

- ☒ = Schleifz.
- * = 0.5 mm
- = 0.5x45°
- X = 1 x45°
- = 1.5x45°
- ▽ = 2 x45°
- = R 0.5
- ⊗ = R 1
- = R 1.5
- ∩ = R 2
- R = R 2.5

Profils de joue

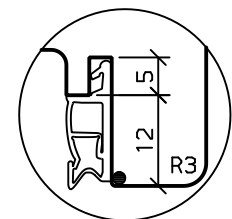

reprise supplémentaire

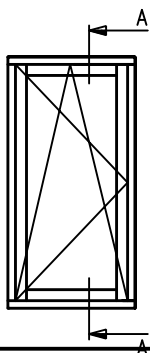
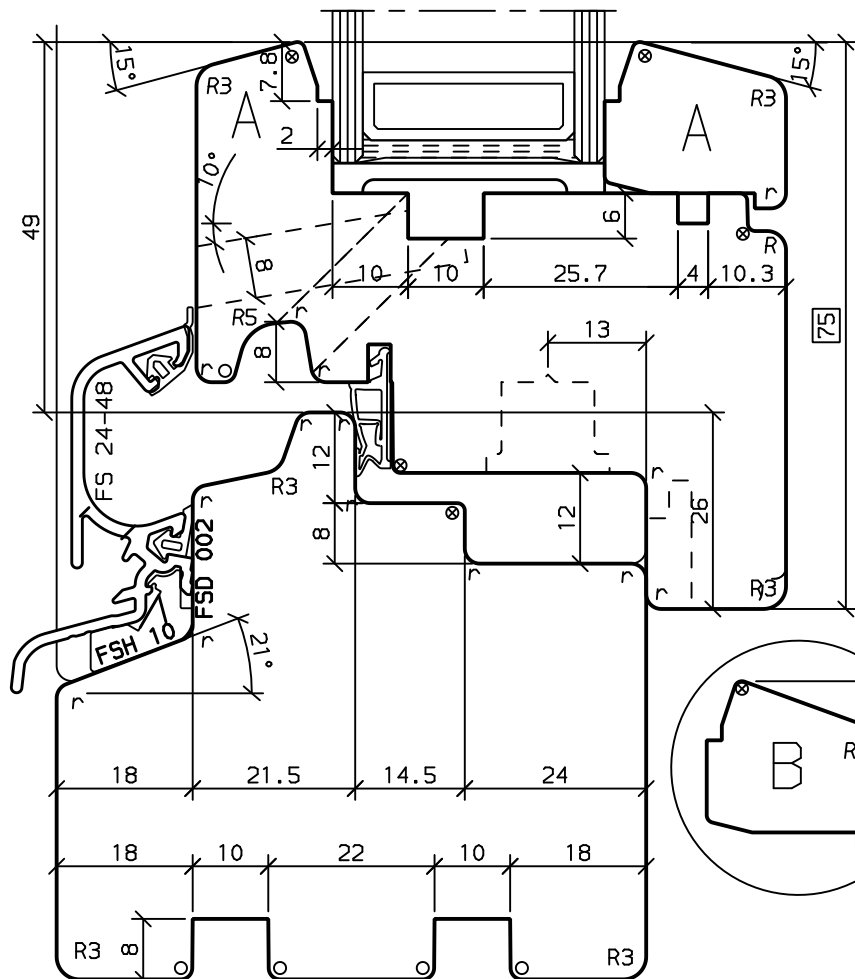
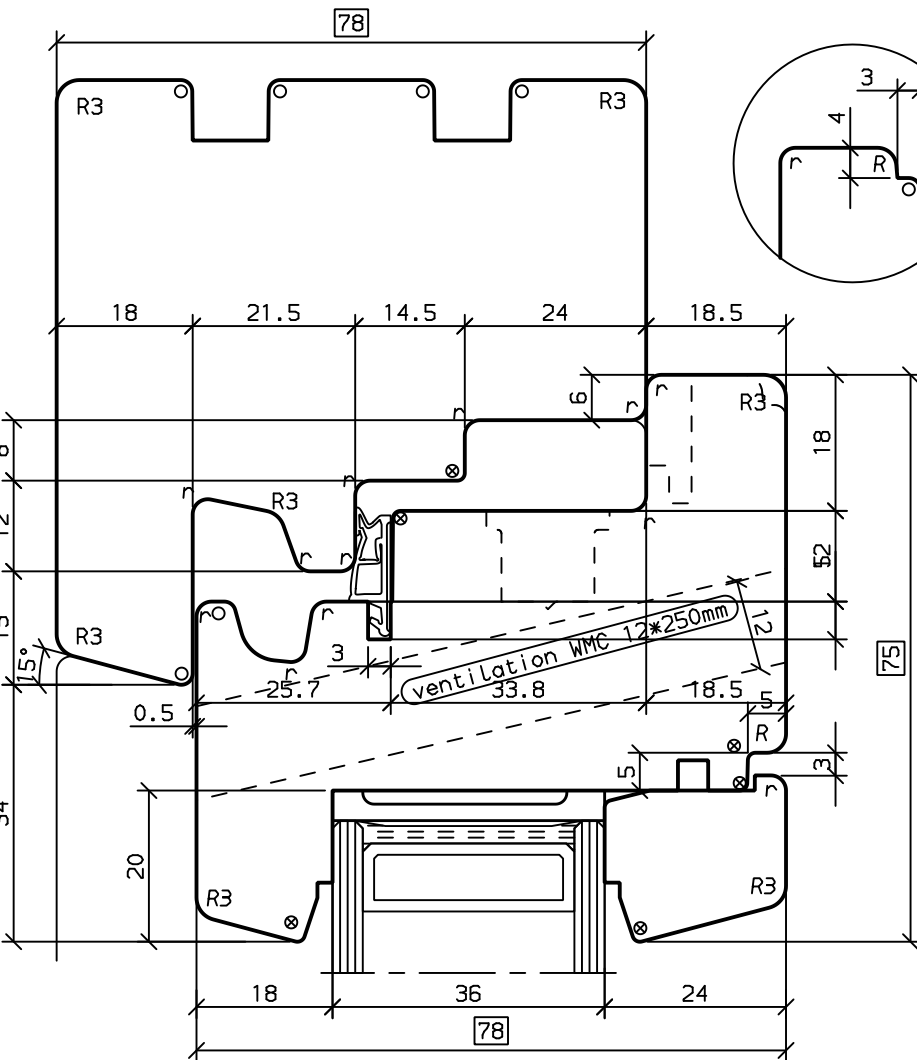
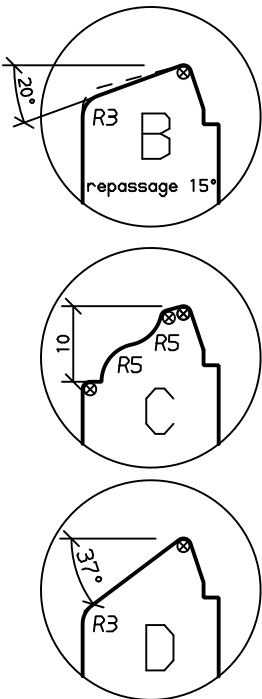
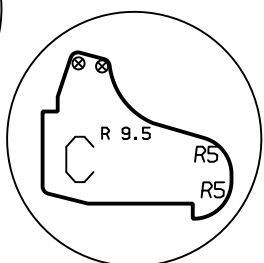

OERTLI

Ers.dr.
Ers.f.:

**FENÊTRE BOIS 78/78MM
COUPE VERTICALE
REJET D'EAU ALUMINIUM**

Maßstab 1:1	A4 Gez.	01.08.18	LAO
K-Nr.	1005324	Gepr.	22.02.19
K-Name	OE-F. MINAIRE		

SD 1519683 200 01 A

- ☒ = Schleifz.
- * = 0.5 mm
- = 0.5x45°
- ✕ = 1 x45°
- = 1.5x45°
- ▽ = 2 x45°
- = R 0.5
- ⊗ = R 1
- = R 1.5
- ⌒ = R 2
- R = R 2.5

Profils de joue

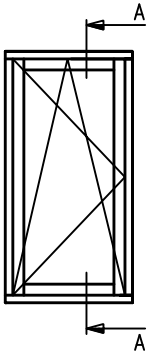
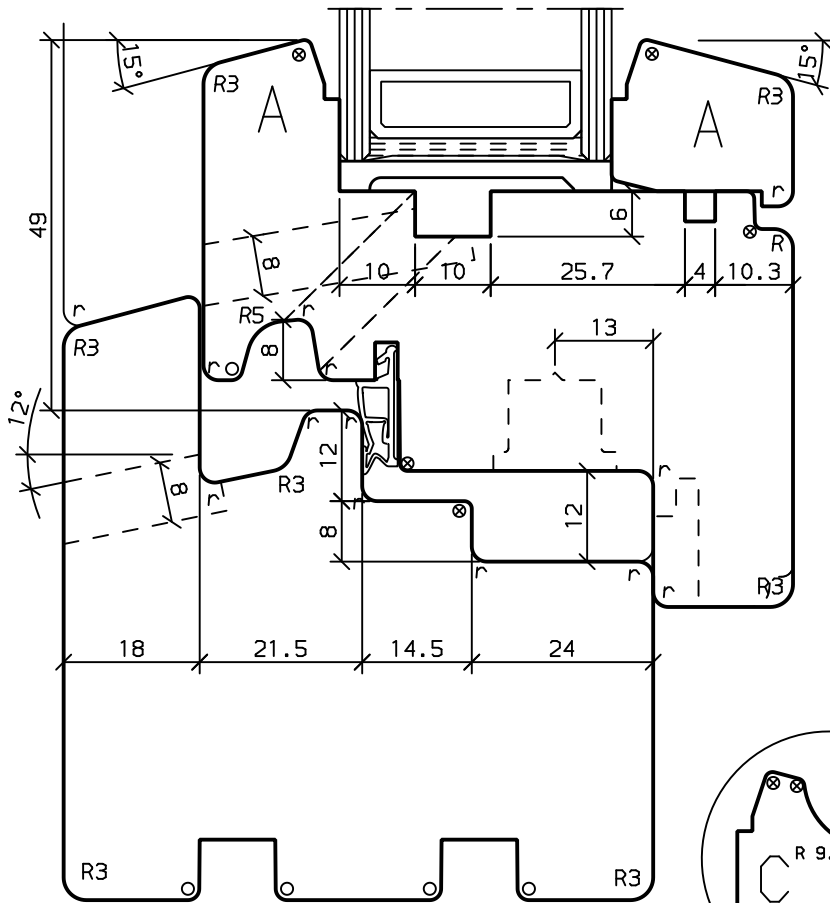
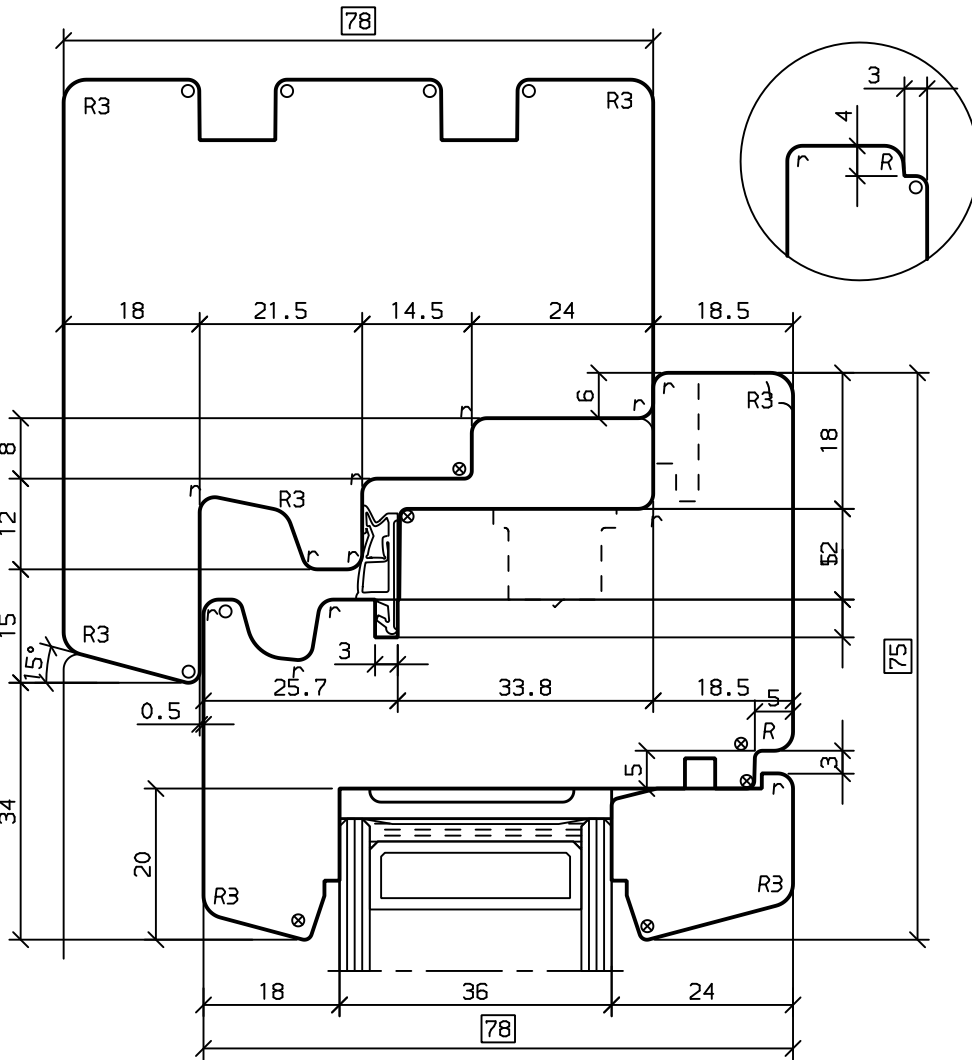
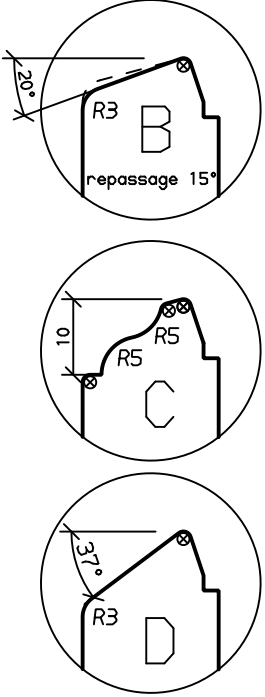

Maßstab 1:1	A4	Gez.	01.08.18	LAO
K-Nr.	1005324	Gepr.	22.02.19	KOG
K-Name OE-F. MINAIRE				
SD 1519683 201 01 A				

FENÊTRE BOIS 78/78MM
COUPE VERTICALE
SANS REJET D'EAU

OERTLI
Ers.dr.
Ers.f.i.

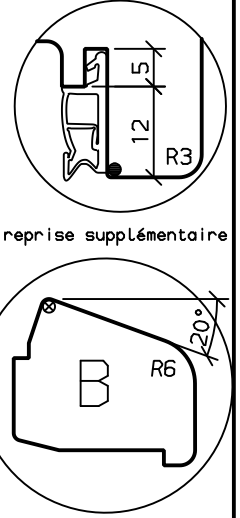

reprise supplémentaire

- ☒ = Schleifz.
- * = 0.5 mm
- = 0.5x45°
- X = 1 x45°
- = 1.5x45°
- ▽ = 2 x45°
- = R 0.5
- ⊗ = R 1
- = R 1.5
- r = R 2
- R = R 2.5

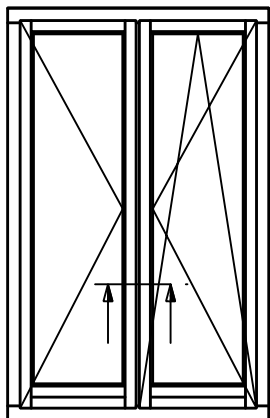
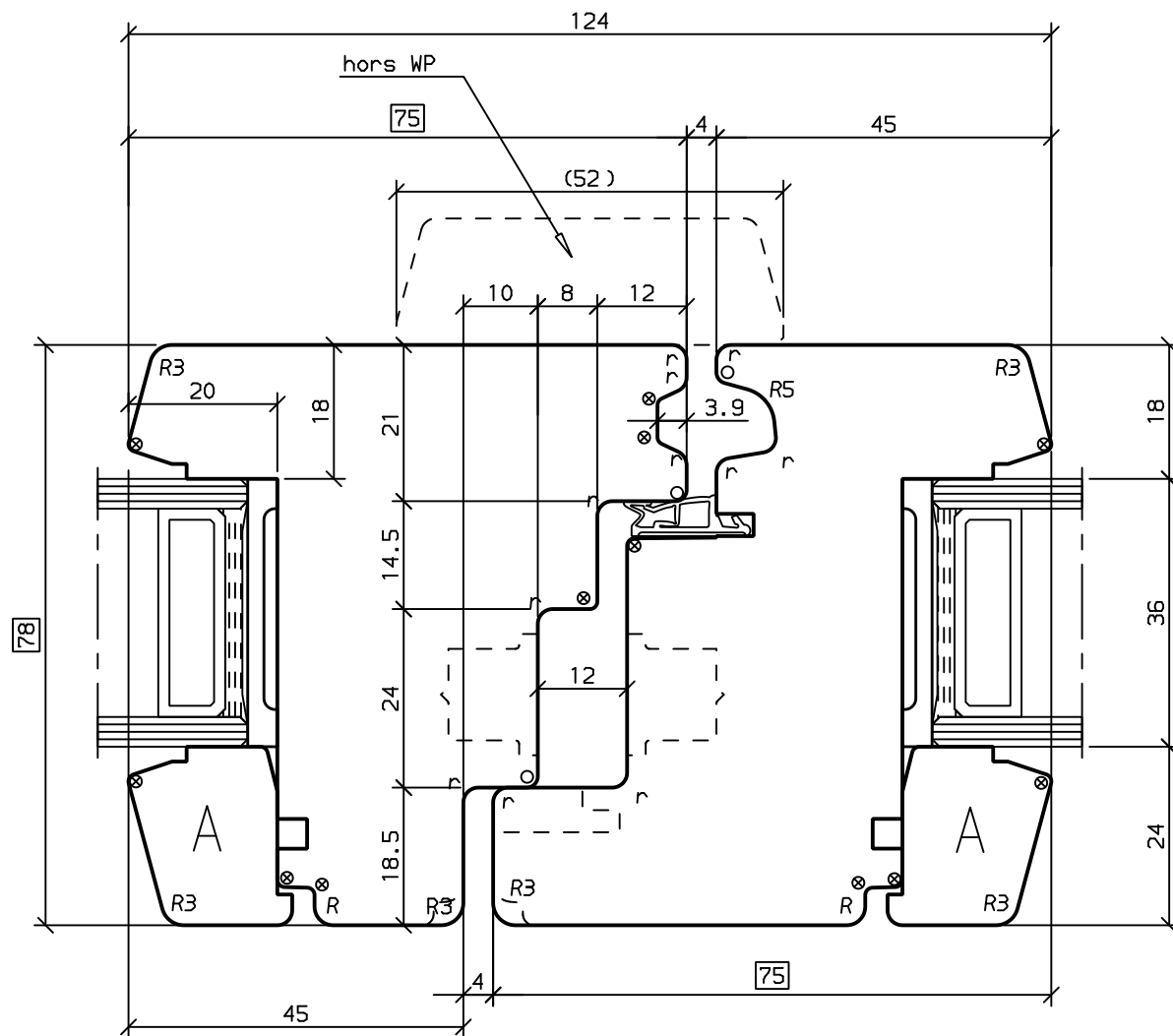

OERTLI	FENÊTRE BOIS 78/78MM PARTIE CENTRALE				Maßstab	1:1	A4	Gez.	01.08.18	LAO
					K-Nr.	1005324	Gepr.	22.02.19	KOG	
	Ers.d: . Ers.f: .					K-Name OE-F. MINAIRE				
					SD 1519683 203 01 A					

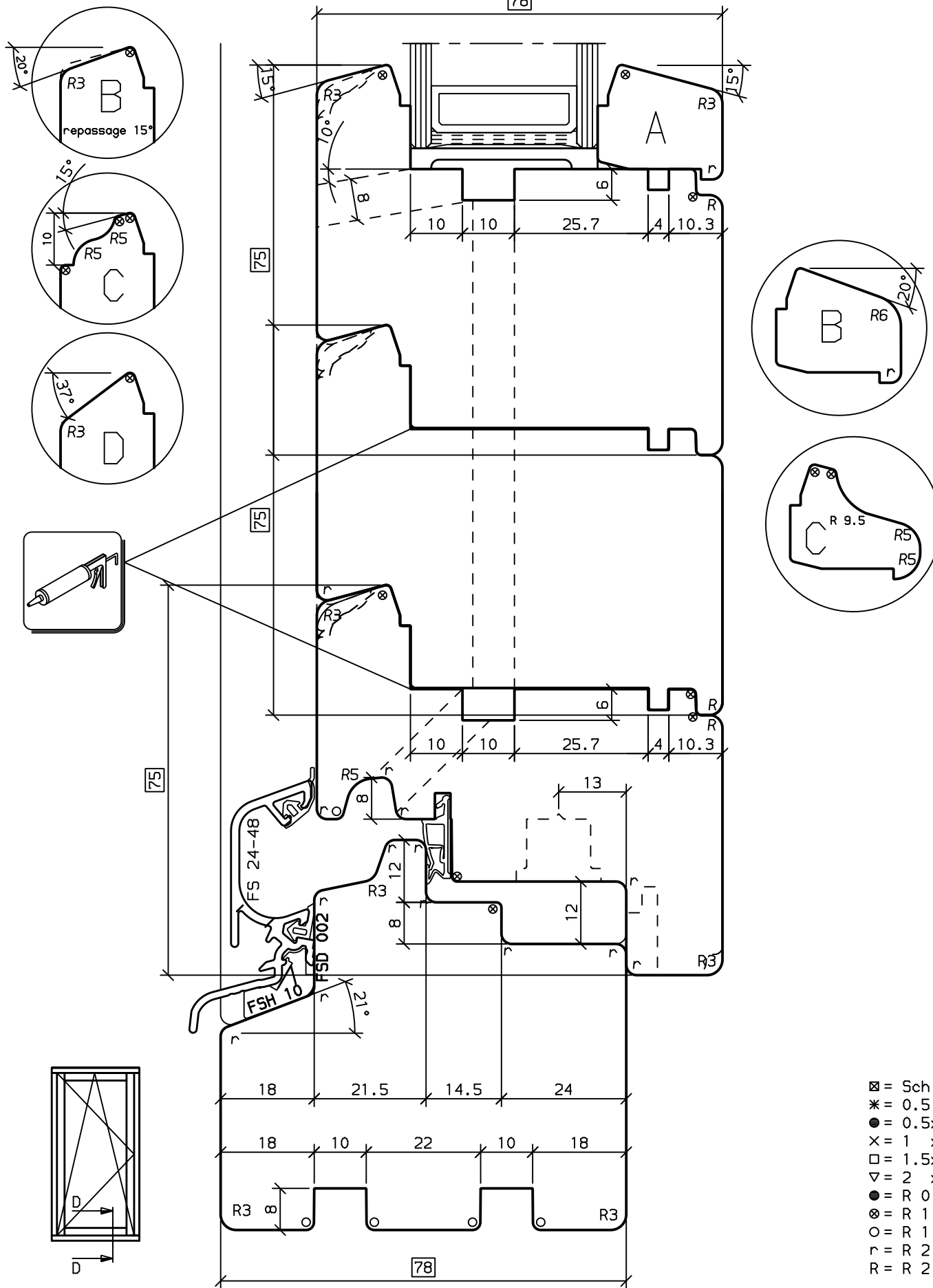

- ☒ = Schleifz.
- * = 0.5 mm
- = 0.5x45°
- × = 1 x45°
- = 1.5x45°
- ▽ = 2 x45°
- = R 0.5
- ⊗ = R 1
- = R 1.5
- r = R 2
- R = R 2.5

OERTLI

Ers. d: .

Ers. f: .

Maßstab	1:1	A4	Gez.	02.08.18	LAO
K-Nr.	1005324	Gepr.	22.02.19	K0G	
K-Name	OE-F. MINAIRE				
SD 1519683 206 01 A					

- ⊠ = Schleifz.
- * = 0.5 mm
- = 0.5x45°
- × = 1 x45°
- = 1.5x45°
- ▽ = 2 x45°
- = R 0.5
- ⊗ = R 1
- = R 1.5
- ⌢ = R 2
- R = R 2.5

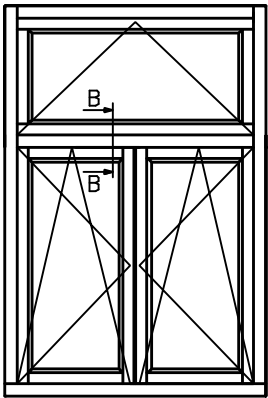
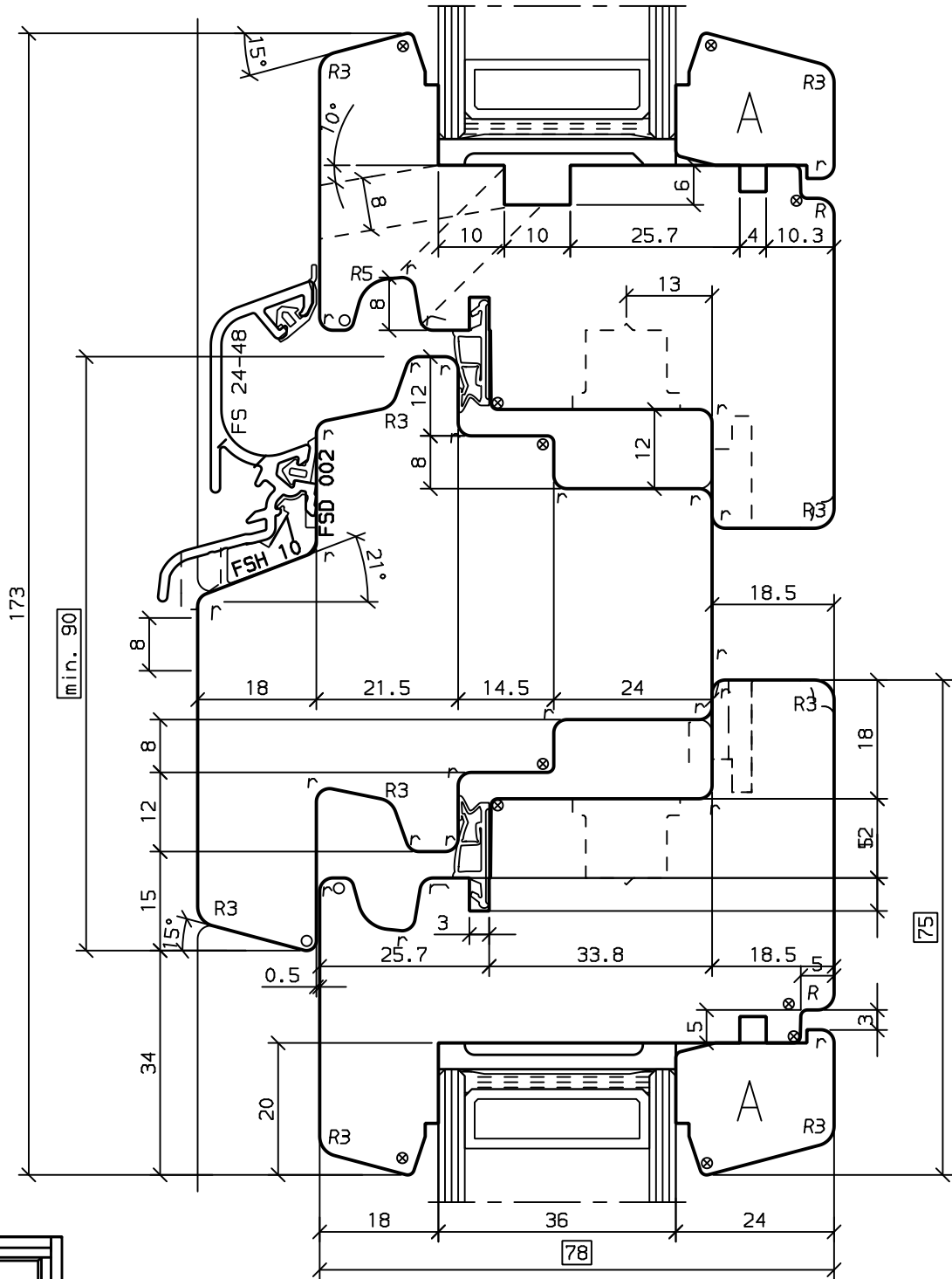

OERTLI 

FENÊTRE BOIS 78/78MM
 COUPE VERTICALE
 TRAVERSE INTER HORIZONTALE

Maßstab	1:1	A4	Gez.	02.08.18	LAO
K-Nr.	1005324	Gepr.	22.02.19	K0G	
K-Name	0E-F. MINAIRE				

SD 1519683 207 01 A

Ers. d.:
 Ers. f.:

- ☒ = Schleifz.
- * = 0.5 mm
- = 0.5x45°
- X = 1 x45°
- = 1.5x45°
- ▽ = 2 x45°
- = R 0.5
- ⊗ = R 1
- = R 1.5
- ⌣ = R 2
- R = R 2.5

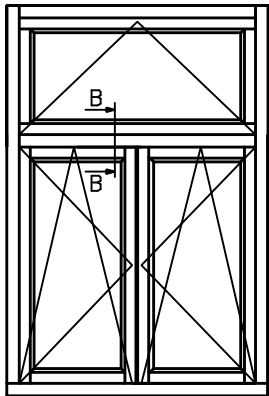
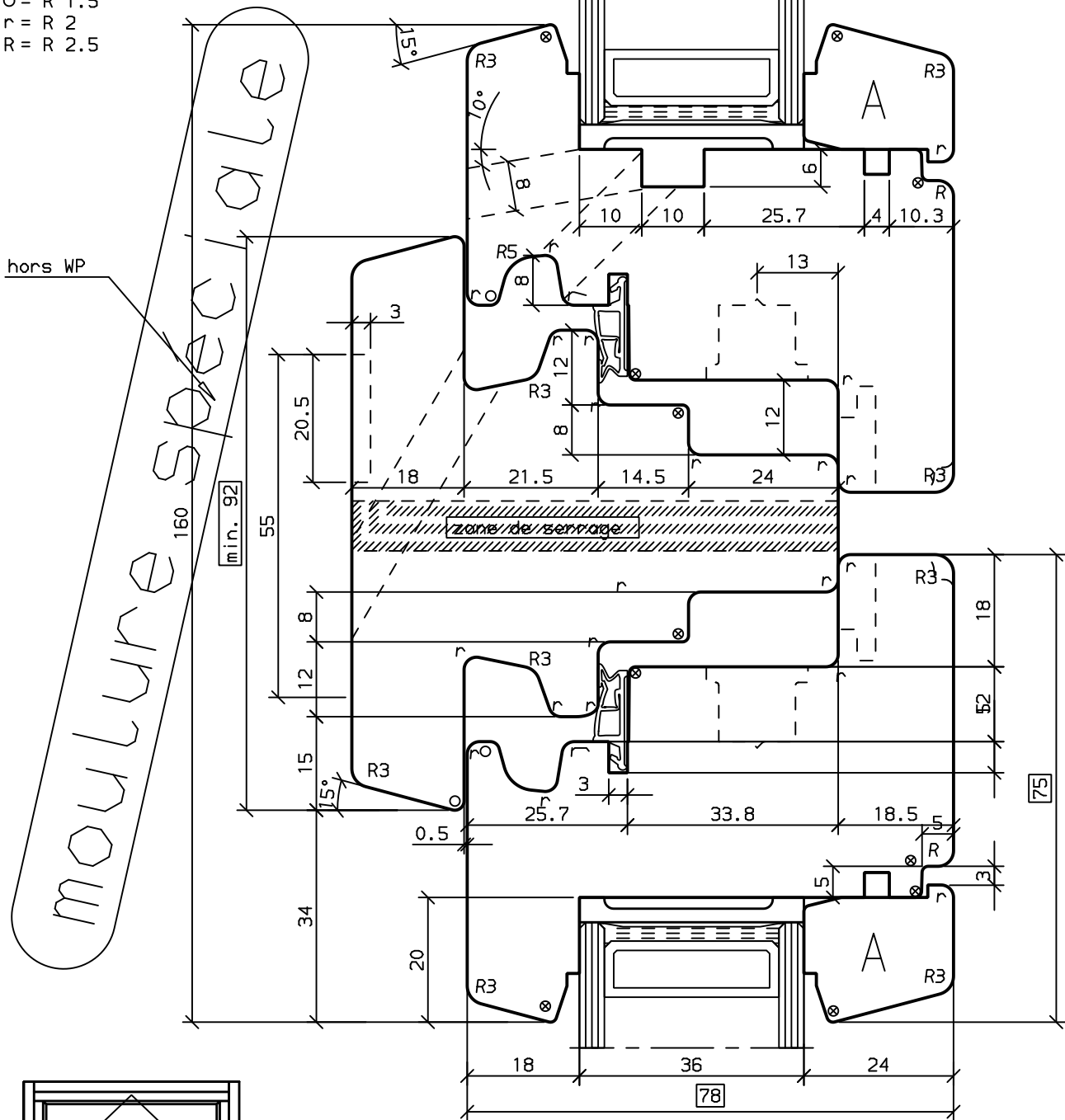

OERTLI 

FENÊTRE BOIS 78/78MM
 COUPE VERTICALE
 TRAVERSE TOUT BOIS

Maßstab	1:1	A4	Gez.	02.08.18	LAO
K-Nr.	1005324	Gepr.	22.02.19	KOG	
K-Name	0E-F. MINAIRE				

SD 1519683 208 01 A

Ers. d.:
 Ers. f.: